

HOIST PUSH BUTTON SWITCH

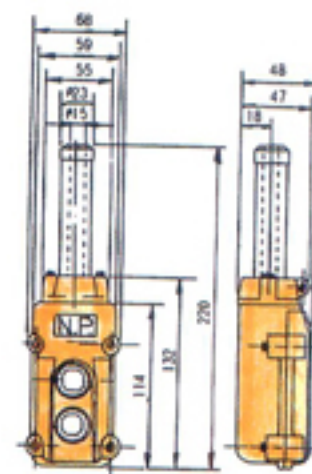
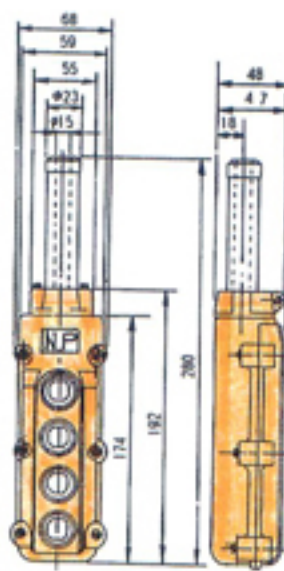
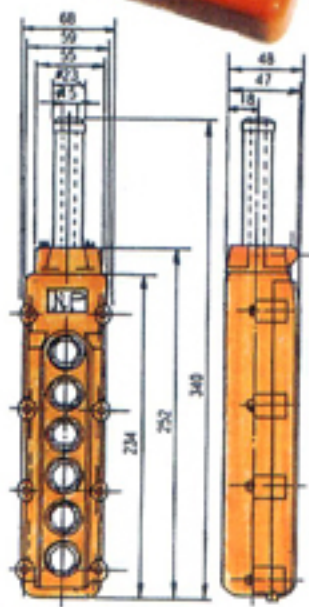
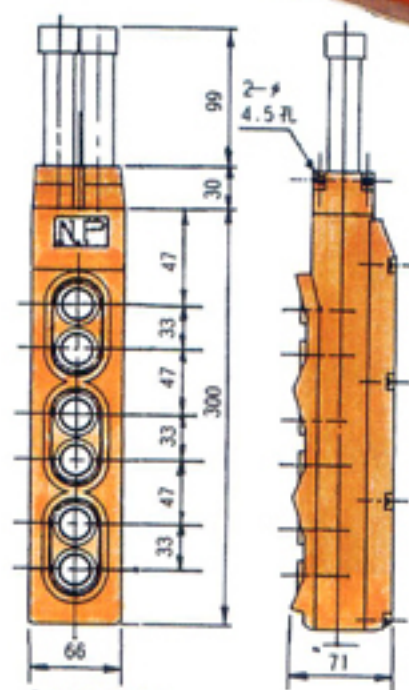
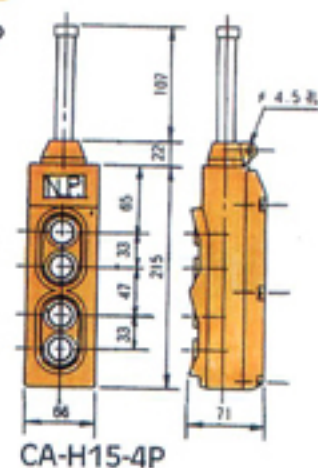

CA-H15-6P

CA-H5-6P

CA-H5-4P

CA-H5-2P

ORDER CODE NO.	SPECIFICATION
CA-H2P	ONE PHASE 250V 15A
CA-H5-2P	250V 5A
CA-H5-4P	250V 5A
CA-H5-6P	250V 5A
CA-H15-2P	250V 15A
CA-H15-4P	250V 15A
CA-H15-6P	250V 15A

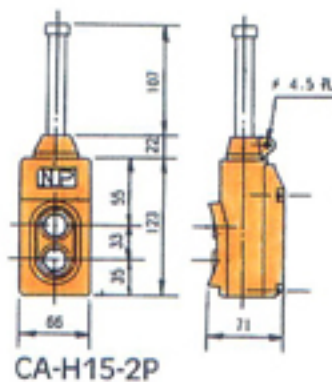

CA-H15-2P

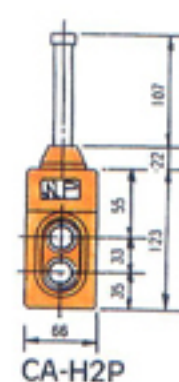

CA-H2P